

REGLOPLAS 

En

90XL

Operating Instructions



Documentation Temperature Control Unit 90XL

This documentation is copyrighted. Unauthorised duplication is prohibited by law. To the best of our knowledge and belief, the information contained in this documentation is true and correct as of the date of publication. The contents, however, do not constitute a binding obligation on the part of Regloplas AG and are subject to change without notice.

© Copyright 2011 Regloplas AG

All rights reserved

Printed in Switzerland







Contents

General Safety Information	1
Safety Symbols	1
Range of Application	2
Intended Use	2
Safety Information	2
General Information	2
Process Monitoring	2
Information for Operators and Personnel	3
Changing the Parameter Settings	3
Residual Risks	3
Using This Documentation	4
Additional Documentation	4
Operating Instructions	5
General	5
Introduction	5
Operating Range	5
Start-up	6
Setting up the temperature control unit	6
Operating Instructions	7
Inspection of Consumers	7
Water quality	7
Connecting Lines	9
Electrical Connections	10
Exhaust of the Pump	10
Operation of the Temperature Control Unit	11
RT200 Control System	11
Control elements	11
Symbols	12
RT200 Operation and Status Displays	12
Setting the Set-point values	13
Set-point toggling function SP1/SP2	13
Menu	14
Control elements	14
RT200 Control System - Functions	15
Switching on	15
Draining the Consumer (Option)	15
User	16
Operation with Code/Password	16
Save/Load of the Setting Values	16
Operation with Timer (MP2000)	16
RT200 Control System – Unlocking Options	18
Switching off	18
Changing Consumers/Decommissioning	18
Alarm Messages	18
Alarm list	19
Warnings	19
Alarme	20

Systemfehler/Systemmeldungen.....	23
Maintenance	24
Periodic Inspections and Maintenance Procedures	24
Cleaning.....	26
Repairs	26
Transport	27
Disposal	27
Maintenance	28
Technical Data 90XL	28
Block Diagram 90XL.....	29
Graph (pump capacity).....	30
Graph (cooling capacity).....	30
Components/Spare parts 90XL	31
Components/Spare parts 90XL	33
Dimension Sheet 90XL.....	34
Solenoid valve Y6	35
Overview	35
Level Switches.....	35
Dismantling/Replacement.....	35

General Safety Information

Safety Symbols

 DANGER	
	Denotes imminent danger. Failure to heed the information can result in death or severe personal injury (disability).
 WARNING	
	Denotes a dangerous situation. Failure to heed the information can result in death or severe personal injury (disability).
 CAUTION	
	Denotes a potentially dangerous situation. Failure to heed the information can result in property damage as well as minor or moderate personal injury.
NOTE	
	Denotes general information, useful advice to users and work recommendations, which, however, do not have any influence on the safety and health of personnel.

Range of Application

This general safety information is generally valid for all temperature controllers and control systems from Regloplas.

Intended Use

The Regloplas temperature control unit is built according to the current state of the art and the generally accepted principles of safety engineering. The temperature control unit is intended solely for normal use in the heating and/or cooling of injection moulds and die casting dies, extruders, calenders, mixers and other energy-consuming loads ("consumers") in areas where there is no risk of explosion.

Any use beyond this shall be deemed to constitute improper use. The manufacturer is not responsible for damage resulting from improper use; the user is solely responsible for such risks. The temperature control unit may not be used under operating conditions and/or with media deviating from our specifications without the prior consent of Regloplas AG.

The intended use also entails compliance with the operating, servicing and maintenance conditions stipulated by the manufacturer. The temperature control unit may only be operated, serviced and maintained by personnel that are familiar with these tasks and have been instructed as to the risks.

Safety Information

General Information

The Regloplas temperature control unit is safe to operate but can cause danger if it is used incorrectly or for a purpose other than its intended use. It should be noted that any such incorrect use or non-compliance with the intended use can cause risks to the life and limb of the operator or third parties, adverse effects on the equipment and other material assets belonging to the user, and risks to the efficient operation of the equipment.

Start-up (i.e., commencement of intended use) is prohibited until certification that the temperature control unit has been set up and wired in accordance with the Machinery Directive (2006/42/EC). EN 60204-1 (Safety of Machinery) must also be observed.

These Operating Instructions must be read carefully before switching on and operating the temperature control unit. The information regarding the intended use and foreseeable misuse must be observed. Local safety regulations must also be obeyed.

If the temperature control unit is used in combination with products made by other manufacturers, the notices and safety regulations of these manufacturers must also be obeyed.

Process Monitoring

In plants in which a malfunction of the temperature control system leads to endangerment of the operating personnel or destruction of the plant, an independent process monitor that reliably shuts down the plant must be used.

Information for Operators and Personnel

The operator and all persons who are tasked with working on the temperature control unit must obey the fundamental regulations regarding work safety and accident prevention. The operator must ensure that only persons who have read and understood these Operating Instructions, in particular the chapter on safety, may work on the temperature control unit.

Any working methods that have a negative effect on the technical safety of the temperature control unit must not be used. The operator must ensure that the temperature control unit is operated only in flawless condition. If necessary, the company using the equipment must obligate the operating personnel to wear protective clothing.

For all tasks relating to set-up, start-up, operating, modification of operating conditions and operational methods, maintenance, inspection and repair, any shut-down procedures stated to be necessary in the Operating Instructions must be followed.

Changing the Parameter Settings

The parameterisation of the control system may only be carried out by personnel trained by Regloplas. In particular, no parameters in the device configuration may be changed without consulting Regloplas.

The relevant accident prevention regulations and the generally accepted principles of safety engineering, occupational medicine and structural engineering must be observed. The national safety regulations must also be obeyed.

Residual Risks

Any unauthorised modifications and changes to the temperature control unit as well as unauthorised changes to the parameterisation of the control system are prohibited for reasons of safety.

If the temperature control unit is damaged, it must not remain in use; the defective part must be replaced or repaired immediately. Only original Regloplas replacement parts may be used. Damage due to the use of third-party parts renders any and all warranty claims null and void.



DANGER



The temperature control unit must be disconnected from the electrical power supply before it is opened (unplug the mains plug and, if fitted, press the main switch on the temperature control unit). Danger of electric shock!

Any leaks in the temperature control circuit (control unit, connecting lines, consumers, etc.) must be repaired immediately.

In the case of temperature control units that use oil as the heat transfer medium, please remember that oil is flammable under certain conditions. For this reason, the temperature control unit must not be located close to heat sources. The thermal insulation in the device must always be kept clean. Insulation that is soaked with thermal oil poses an increased risk of fire.



Burning thermal oil can be extinguished using an AFFF spray foam fire extinguisher, a powder fire extinguisher (to be avoided in the case of dust-sensitive plants, control systems, EDP, etc.) or a CO₂ fire extin-

guisher. The appropriate fire extinguisher must be provided by the operator, taking into account the equipment located in the room and the mandatory safety regulations.

The temperature control unit may only be operated when all safety systems are completely installed and intact.

The temperature control unit must be protected against sprays and cleaning agents.

Before detaching connecting lines from the temperature control circuit, first allow the temperature control unit to cool down, as a function of the outlet temperature, and then switch it off. Check that the pump is no longer running.

 WARNING	
	Important - danger of injury in the event of escaping water or oil!

Using This Documentation

This documentation contains important information for safe and economical operation and proper maintenance of the device.

Compliance with this documentation helps to avoid danger, minimise repair costs and downtime, and increase the dependability and service life of the device/system.

NOTE	
	The operating instructions should be kept near the corresponding device/system and always be accessible to operating and maintenance personnel.

Additional Documentation

The included documentation is completely correct for the basic versions of devices. Components that do not belong to the basic hardware are noted as extra equipment. The corresponding additional documents are included with special versions of devices. Any additional documents supplement and/or replace the descriptions contained in this documentation, which are then either invalid or only conditionally valid.

Operating Instructions

General

Introduction

These Operating Instructions contain a detailed description of the Temperature Control Unit 90XL as well as important information for safe operation and optimal maintenance.

The Operating Instructions must be kept near the temperature control unit and must always be accessible to operating and maintenance personnel.

Operating Range

The operating range and the heat transfer fluid of the temperature control unit are shown in the following table (see also the chapter "Technical Data" in the Maintenance section).

Temperature Control Unit Type	90XL
Temperature range	up to 90 °C
Heat transfer medium	Water

NOTE	
	<p>The technical data and information for installation, start-up and maintenance of the temperature control unit can be found in the maintenance section of these operating instructions. The Operating Instructions must be kept near the device/system and must always be accessible to operating and maintenance personnel.</p>

NOTE	
	<p>Installations in Canada and the United States of America: Preliminary fuse (in class CC or class J) must be installed by the customer, according to the specification in the electrical diagram.</p>

Start-up

Setting up the temperature control unit

The temperature control unit is designed for an ambient temperature range of 10-40 °C. Sufficient ventilation must be provided during setup. The distance between the devices and/or between the temperature control unit and a wall must be at least 10 cm. The ventilation slits must not be covered.

- Check the temperature control unit to ensure that it is undamaged and complete
- Do not tip the temperature control unit! Heat transfer medium remaining in the unit from the test run could spill, and there is a risk that the thermal insulation could become soaked with the fluid (medium)
- Position the temperature control unit on a horizontal surface and engage the wheel brake



WARNING



The temperature control unit may be pressurised - danger of injury in the event of escaping hot water or steam.

Never start up the temperature control unit without the side panels and housing.

Never use the temperature control unit in potentially explosive environments and protect it against sprays and cleaning agents that contain solvents.

Any leaks in the temperature control circuit (temperature control unit, connecting lines, consumers, etc.) must be repaired immediately.

(The Regloplas AG leakage monitoring function does not constitute any kind of safety element and any warranty claim against Regloplas AG and its affiliated companies or representatives is excluded for the proper functioning, even in conjunction with a die-casting or injection moulding machine.)

Observe local laws during set-up.



CAUTION



Before detaching connecting lines in the temperature control circuit, the temperature control unit must first be allowed to cool down. The cooling time will depend on the outlet temperature. The shutdown procedure is initiated by pressing the ON/OFF button. The pump continues to run. The temperature control unit cools down until the temperature of the heat transfer medium has reached the programmed coastdown temperature (factory default 60 °C). The pump and the control system are then switched off.

Check that the pump is no longer running and that the system pressure gauge reads 0 bar (display on the screen reads OFF).

The corresponding chapters of the Operating Instructions must be read before starting up the temperature control unit.

Operating Instructions

The Operating Instructions for the temperature control unit must be kept at all times close at hand for the personnel responsible for start-up and operation. Please ensure that the operating instructions are read. By doing so, you will avoid unnecessary expense and problems during start-up as well as production downtime.

Inspection of Consumers

Before installing the connecting lines between consumer and temperature control unit, the consumer must be subjected to the following inspections:

- Verify that channels are unobstructed
- Remove residual fluid and dirt with compressed air (foreign objects such as shavings etc. can damage the pump)
- Rust and scale deposits must be removed because they greatly interfere with the heat exchange between consumer and heat transfer medium and increase the pressure drop in the consumer. Descaling can be carried out using the Regloplas REG descaling unit (see the "Regloplas Temperature Control Technology" brochure, REG data sheet)

Water quality

Without special treatment, water is generally not suitable for closed temperature control and cooling circuits. Poor water quality leads to corrosion in the temperature control unit and on the tool. Heat transfer functions less efficiently and thus the quality and performance of the temperature control system worsens.

In order to maintain the quality of the temperature control system and to avoid damage to the temperature control unit or the attached consuming device (tool), the water used has to fulfil certain requirements. Depending on the maximum flow temperature, a fundamental distinction is made in the following two types:

- With flow temperature of up to 160 °C, so-called hardness stabilisers such as the **RK 93** from Regloplas can be used.
- With flow temperature of 180 °C or more, the water has to be desalinated. Then a corrosion inhibitor such as **RK HT** from Regloplas has to be used to stabilise the pH level.

The following points must also be observed with regard to the water quality:

- Hard water is not suitable due to the high levels of chalk it contains.
- Rusty water can cause even stainless steel to corrode.
- Water containing chlorine leads to pitting corrosion.
- Seawater should not be used under any circumstances.
- Untreated stream water and cooling tower water should not be used due to its microbiological content.
- The water must be free of suspended solids or sediment (use filters).

- Aluminium should be avoided in the temperature control circuit as special precautions are then required.
- The water in the temperature control circuit has to be exchanged regularly. Regloplas units offer the possibility of cyclical exchange of the system water (**rinsing**).

NOTE



For high flow temperatures, the system water must be prepared as described. The cooling water does not have to meet the same strict requirements as the system water.

Regloplas temperature control units with indirect cooling have optional separate connections for the system water and the cooling water.



CAUTION



If the temperature control unit is operated with unsuitable water, this will render any warranty claims invalid in case of damage to the temperature control unit.

Flow temperatures up to 160 °C

With a flow temperature of up to 160 °C, so-called hardness stabilisers such as the **RK 93** from Regloplas can be used.

The following approximate values must be adhered to:

Criterion	approximate value
Appearance	Clear with no sediment Free of solid matter
Cloud	< 0.0 NTU (no cloudiness)
Total hardness	< 10 °dH
pH value	7.5-9.0
Conductivity	Max. 500 µS/cm
Carbonate hardness	< 5 °dH
Chloride ions Cl-	< 30 mg/l
Sulphate So4	< 150 mg/l
Ammonium NH4	< 1 mg/l
iron	< 0.2 mg/l
Manganese	< 0.1 mg/l

Flow temperatures of 180 °C or more

With a flow temperature of 180 °C or more, the water has to be desalinated. Then a corrosion inhibitor such as **RK HT** from Regloplas has to be used to stabilise the pH level.

The following approximate values must be adhered to:



Criterion	approximate value
Appearance	Clear with no sediment Free of solid matter
Cloud	< 0.0 NTU (no cloudiness)
Total hardness	< 1 °dH
pH value	7.5-9.0
Conductivity	Max. 50 µS/cm
Carbonate hardness	< 1 °dH
Chloride ions Cl-	< 5 mg/L
Sulphate So4	< 150 mg/l
Ammonium NH4	< 1 mg/l
iron	< 0.2 mg/l
Manganese	< 0.1 mg/l

When no water of suitable quality is available, an appropriate additional device such as the **waterCare** from Regloplas should be used.

Connecting Lines

The connecting lines must consist only of pressure-resistant and temperature-resistant hoses and screw fittings. The cross-section of the connecting lines may not be reduced (see maintenance section).

- Outlet and inlet - dimensioning for 140/160 °C (16 bar) and 180/200 °C (25 bar) The connecting lines must be routed so that they are protected against unintentional contact. Thermal expansion must be taken into account in pipe joints
- Cooling water inlet - dimensioning for 100 °C (10 bar). When connecting to public water mains, the applicable laws and safety regulations must be observed (e.g., connection of the unit via circuit separator). The water mains pressure must be within the range of 2-5 bar. The minimum cooling water flow rate must be 10 l/min
- Cooling water outlet - dimensioning for 160 °C (10 bar), must prevent reverse flow and must be always open. The hose must be fastened so that any escaping steam at the start of the cooling procedure does not pose a hazard
- For reasons of safety, the cooling system must always be connected

 CAUTION	
	When escaping, the temperature of the cooling water can increase to the same temperature as the heat transfer medium!

Electrical Connections

The temperature control unit may only be connected by a qualified electrician.

- Compare supply voltage and frequency with the information on the rating plate of the temperature control unit
- Verify the rating of the preliminary fuse according to the information in the electrical diagram, and check that the power consumption conforms to the value on the rating plate of the temperature control unit
- Observe the applicable local laws and safety regulations when connecting to the mains

Exhaust of the Pump

At start-up or refilling of the temperature control unit, the exhaust of the pump is necessary. For this purpose, during pump operation, the bleed screw is opened slightly until the air has been completely exhausted and water escapes. Then the bleed screw is tightened again.

CAUTION



The exhaust of the pump must take place before using the temperature control unit!
A dry running can result in damaging the pump bearings and the floating-ring shaft seal!

Operation of the Temperature Control Unit





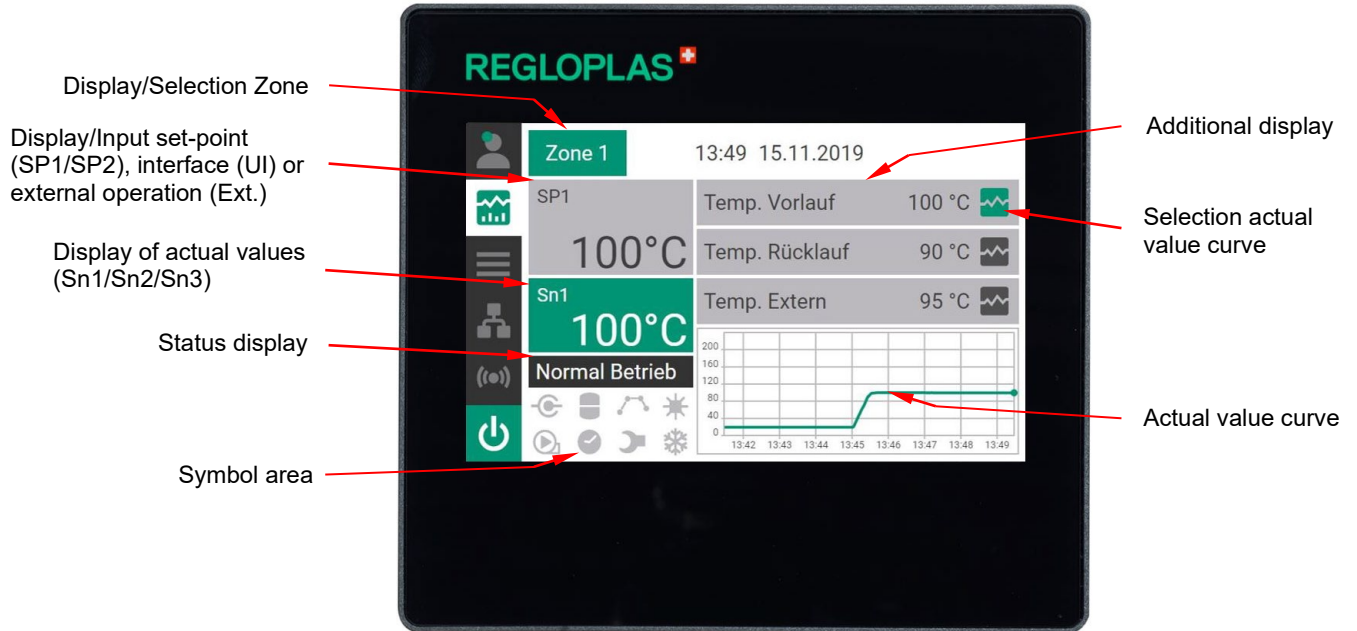



The temperature control unit must only be switched on after inspecting the consumer, connecting the connecting lines and electrical connections, and opening the outlet/inlet shut-off valves. The vent valves on the consumer and the shut-off valves (if present) must be open.

RT200 Control System













RT200 Control System – front panel

Control elements

	User		Display/Input set-point value (SP1/SP2)
	Main screen		Selection actual value curve
	Menu		Switchover actual value curve
	Multiflow		
	Alarm reset and alarm history		
	ON/OFF		

Symbols

	Interface operation		Feed pump, clockwise rotation
	Level of the heat transfer medium (filled quantity) lower level		Level of the heat transfer medium (filled quantity) upper level
	Ramp program activated		Timer activated
	Heating		Cooling
	Feed pump, counterclockwise rotation		Maintenance due (flashes if maintenance is due)

RT200 Operation and Status Displays



In the off state of the RT200 Control system, the message **OFF** appears in the status display. The top left part of the display shows the set-point temperature **SP1** or **SP2** (SP = Set point). The actual outlet temperature (actual value from temperature sensor Sn1, Sn2 or Sn3) is displayed below. Above the display and selection of the zone.

Sn1 = Outlet temperature

Sn2 = Temperature, external

Sn3 = Inlet temperature



The lower left part of the display shows various operational and status displays of the temperature control unit (**symbol area**).



In the right middle part of the display, three more selectable values are shown. The **additional display** is set by pressing the corresponding button (Select parameter screen opens and the desired value for the additional display can be selected). The **actual value curve** is displayed below and the desired value of the additional display can be selected with the button **Selection actual value curve** for visualization. By touching the **actual value curve**, the display is enlarged and can be toggled with the button **switchover actual value curve**.

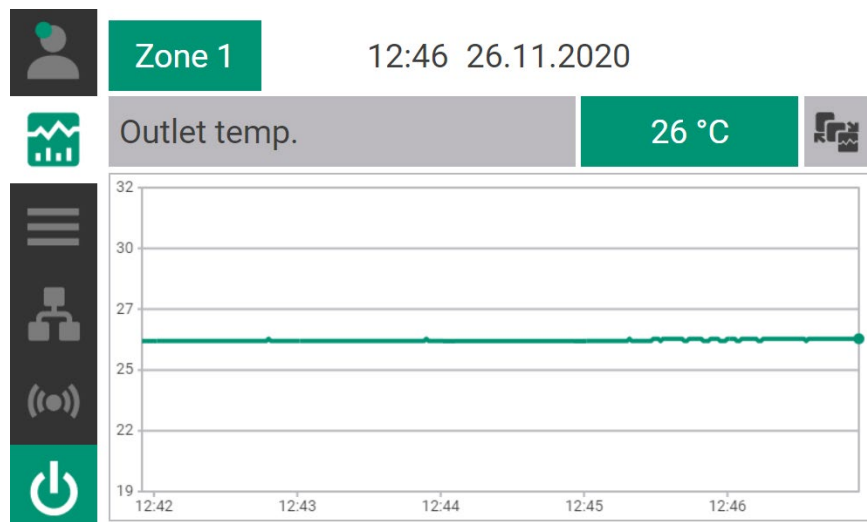

The **time scaling** can be set by tapping the time axis. By tapping the value axis, the **value scaling** mode can be selected between Auto or Man-

ually. For the manual value scaling the minimum and maximum values can be entered by tapping the value axis in the lower and upper area.

Setting the Set-point values



The setpoints **SP1** and **SP2** are set by touching the grey-shaded button **Display/Input set-point (SP1/SP2)** (The input window opens, the new value can be entered and confirmed with ✓). The set-point values can also be selected through an external digital signal.

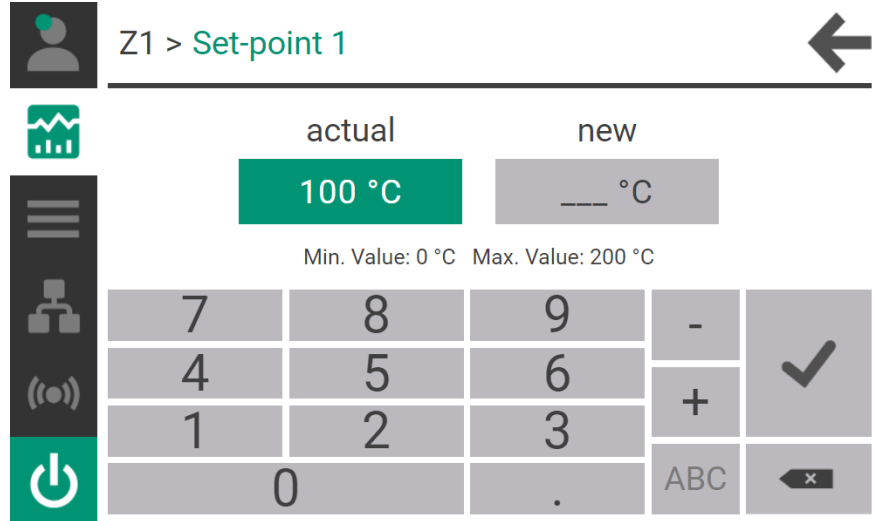

Set-point toggling function SP1/SP2



To toggle between set-point values **SP1** and **SP2** this is done in the menu screen by selecting the **set-point toggling function**. Set-point toggling is only possible if there is no alarm pending.







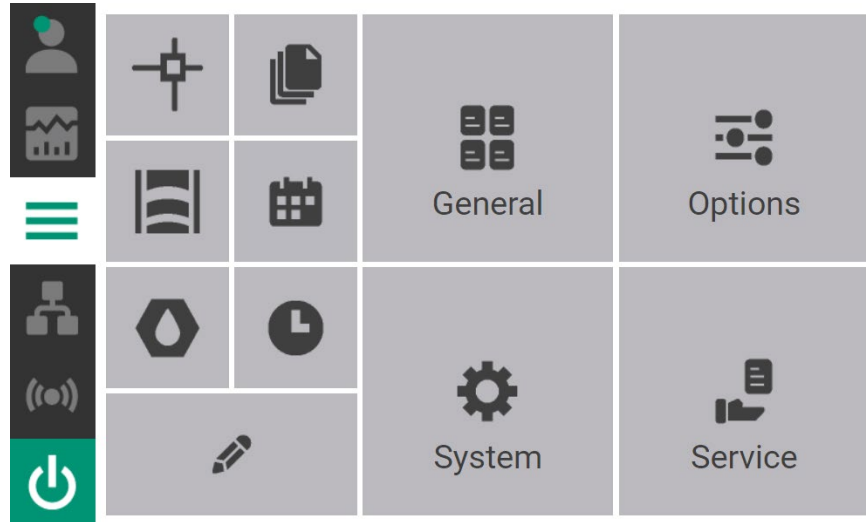



Menu



The menu is activated by pressing the **Menu** button. Here, all configurations and parameters can be set, as well as device functions (e.g. set-point toggling SP1/SP2, draining, leak-stop operation).



Control elements

	Set-point value toggling SP1/SP2		General
	Draining (suction or blowing out)		System
	Leak-stop mode		Options
	Actual values		Service
	Clock		
	Ramp program		
	Set-point		

RT200 Control System - Functions

Switching on



Upon switching on the main switch, the message **OFF** appears in the display. The RT200 control system is now ready for operation and is switched on by pressing the **ON/OFF** button, or by the timer, through a digital input or an interface.

Depending on the programming, the set-point and actual values, as well as information on the operational state of the control system or the temperature control unit are displayed.

Rotational field detection / Direction reversal

The rotary field detection of the RT200 control system detects a wrong phase sequence and reports this in the display or corrects the direction of rotation automatically.

Draining the Consumer (Option)

The heat transfer medium is drained out of the consumer by suction by means of the feed pump. During this process, the maximum expansion volume must be taken into account (see also "Technical Data" chapter).

Drainage by Suction with Pump (MP2021)



The suction program allows the draining of the consumer connected at the temperature control unit and is activated in the menu screen by pressing the draining button. The pump is switched off, and after the pump run-down time has elapsed the pump is switched on again in the opposite direction. The consumer is drained by suction during the defined period (draining time).

Draining is only possible if the temperature of the heat transfer medium is below the programmed coastdown temperature value. If that is not the case, the heat transfer medium is first cooled to this value.

Blowing out with Compressed Air (MP2022)

The blowing out programme makes it possible to drain the consumer connected to the temperature control unit with compressed air. Blowing out is activated after the pump run-down time has elapsed and directs compressed air through the consumer. The temperature control unit switches off automatically after the set period (draining time) has elapsed.



The suction or blowing out programme can be cancelled by pressing the **ON/OFF** button. When the **ON/OFF** button is pressed again (wait until the display reads **OFF**), the unit switches back to normal operation.

NOTE













In the case of pressurised water units, the pressure release valve closes 5 °C above the run-on temperature value (max. 85 °C) and opens at the programmed run-on temperature value during the cooling process.

User



The user view is activated by pressing the **User** button. Here you can log in or log out the corresponding user by selecting **login/logout**.

User

	Regloplas	login 
	Regloplas AIC	login 
	Service	login 
	Technician	logout 
	User	login 

Operation with Code/Password

In order to prevent the values that have already been set or programmed from being unintentionally reset/adjusted, the use of a code/password is urgently recommended. (**Menu > Service > Code**).

The RT200 Control system has five password levels that are organised hierarchically:

- User password - Default **0000** (switched off)
- Technician password - Default **0100**
- Service password - only for personnel trained by Regloplas
- Regloplas AIC-password – only for Regloplas AICp personnel
- Regloplas-Passwort – only for Regloplas

NOTE



It is strongly recommended that an operator password should be set up when commissioning the temperature control unit!

Save/Load of the Setting Values

The RT200 control system offers the possibility of easily reloading or saving the factory or user settings as well as various other settings at any time (**Menu > Service > Save/Load**).

Operation with Timer (MP2000)

The RT200 Control system has an integrated real-time clock. If the **Timer** option is available, the device can be switched on and off with this option. (**Menu > Options > Switch clock**).

Alarm-Reset and Alarm History

Alarm-Reset



If an alarm has been triggered, the signal horn can be switched off by pressing the **Alarm Reset** button (**Buzzer off**). After the malfunction has been remedied, the alarm can be reset by pressing the **Acknowledge** button.



The **Alarm Reset** button also allows manual acknowledgement of the automatic switchover (toggling) from consumer temperature control **Sn2** to outlet temperature control **Sn1** if sensor **Sn2** is defective or removed from the consumer.

Alarm History



If there is no alarm pending, the **Alarm Reset** button can be used to view the alarm history.

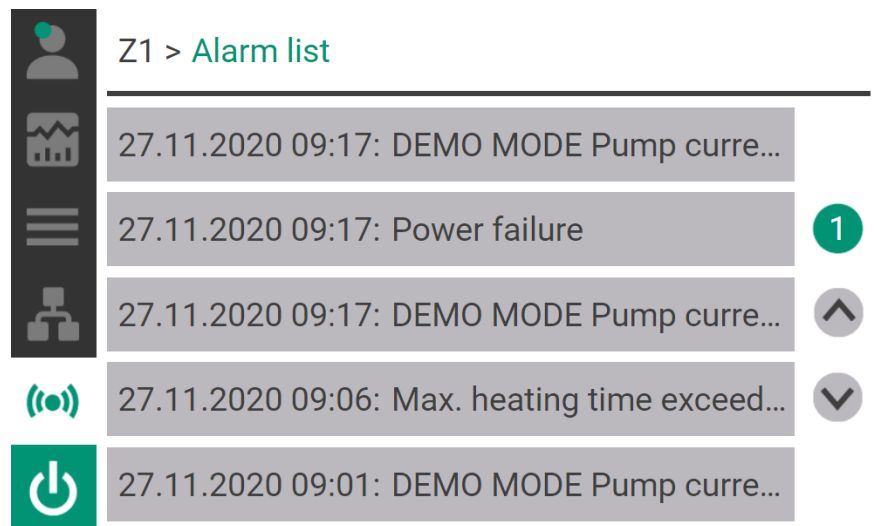

RT200 Control System – Unlocking Options



The RT200 control system can be equipped with different hardware and software options.

The software options must be activated with a file via USB stick. This requires the serial number of the control system, which is displayed in the **Menu > Options > Serial number** and can be seen on the power section of the controller PCB by the barcode.

The serial number consists of 6 letters (e.g. AALASF).

Switching off



The temperature control unit is switched off by pressing the **ON/OFF** button on the RT200 Control system, by the timer, through a digital input or an interface.

Depending on the temperature of the heat transfer medium, the shut-down program runs as follows:

- The pump and the control system are switched off. The RT200 control system will then be in standby mode and the message **OFF** appears on the display.
- The pump continues to run. The unit cools down until the temperature of the heat transfer medium has reached the programmed coastdown temperature. On reaching this temperature, the pump and the control system are effectively switched off. In the case of pressurised water units, the pump then continues running for a further few seconds in the opposite direction (pressure release). The RT200 control system will then be in standby mode and the message **OFF** appears on the display.

Changing Consumers/Decommissioning

Before detaching the connecting lines, it is necessary to verify that the temperature control unit is switched off and that all circuits are depressurized (see the chapter "Switching off"). The temperature control unit must be drained completely and stored in a dry place at 10-40 °C when not in use. To restart the unit, proceed as instructed in the "Start-up" chapter.

Alarm Messages



The RT200 control system can display various error messages (warnings and alarms). Attention must be paid to these error messages without fail. Otherwise, malfunctions of / damage to the temperature control unit and production downtimes may result!

Pressing the **Alarm Reset** button allows you to acknowledge/reset an alarm (e.g. switching off the horn). Only after the malfunction has been rectified can the alarm display be cleared by pressing the **Acknowledge** button.

The **Alarm Reset** button also allows manual acknowledgement of the automatic switchover (toggling) from consumer temperature control (or cascade control) **Sn2** to outlet temperature control **Sn1** if sensor **Sn2** is defective or removed from the consumer.

Alarm list



Pressing the **Alarm Reset** button opens the alarm list, as long as there is no active alarm. The last alarm messages with date and time are displayed here.

Warnings

No.	Error message	Rectification
380	Service is due	Carry out maintenance procedure according to the operating manual. Increment the parameter Next Maintenance by 1000 hours
388	Clean filter	Clean the corresponding filter or if required, replace it
396	Current data lost, load factory settings	The RT200 Control System has lost the parameters and had to load the factory settings
404	Outlet pressure sensor faulty	Replace outlet pressure sensor
412	Heating contactor 1 failure	The contactor Heating 1 does not get actuated correctly any more - replace
420	Heating contactor 2 failure	The contactor Heating 2 does not get actuated correctly any more - replace
428	SSR failure	SSR DC with auxiliary contact has activated. Check SSR
436	Pre-Alarm Flow active in Multiflow Option	Check flow rate (possibly leakage) - adjust pre-alarm settings if necessary
444	Pre-Alarm Temperature active in Multiflow Option	Check temperature - adjust pre-alarm settings if necessary
452	Pre-Alarm Delta T active in Multiflow Option	Check temperature difference - adjust pre-alarm settings if necessary
460	Illegal or broken characteristic curve F1000	Switch the main switch off and on again. If the fault is still present, re-load characteristic curve F1000
468	Pump power too low	Check/inspect the pump or in the menu F1000 reduce the parameter pump tolerance (default 50%)
476	Deviation set-point/actual value underrun	Check deviation set-point/actual value
484	Deviation set-point/actual value exceeded	
492	Deviation set-point value/outlet underrun	Adjust the external temperature and acknowledge the fault or error
500	Deviation set-point value/outlet exceeded	
508	Deviation set-point value/external underrun	Adjust the external temperature and acknowledge the fault or error
516	Deviation set-point value/external exceeded	
524	Deviation set-point value/inlet underrun	Adjust the inlet temperature and acknowledge the fault
532	Deviation set-point value/inlet exceeded	
540	Deviation outlet/inlet underrun	
548	Deviation outlet/inlet exceeded	
556	Max. heating time exceeded	Check heating circuit
564	Max. cooling time exceeded	Check cooling circuit
572	USB stick full	Delete data from USB stick
580	Memory stick missing	Insert memory stick
588	USB stick failure	Replace USB stick
596	Level 2 underrun	Wärmeträger nachfüllen
604	Pressure balance not possible	Wasserzuleitung und Wasserdruck prüfen (min. 2 bar)

No.	Error message	Rectification
612	Current monitoring heating activated	Check heating element(s) and replace if necessary
620	DEMO MODE / Pump current measurement inactive	System message without remedial action
628	Option OPC UA is updating... Do not switch off!	---
636	Option OPC UA has been updated	---

Alarme

No.	Error message	Rectification
692	Toggling of heat transfer medium - unit must be restarted	Switch the main switch off and on again
696	RTC Error or empty battery - Time and date settings lost	Set the correct date/time and/or replace the battery on the front panel
700	Option OPC UA is updating... Do not switch off!	---
704	External set-point value signal interrupted or not present	External set-point value signal must be present (if required, check external control system)
708	Rotation cannot be changed	---
712	Communication interruption on interface detected	Switch on temperature control unit again with main switch - Check communication interface
716	Software version analog option incompatible	Update the software
720	Software version digital option incompatible	
724	Software version option current monitoring incompatible	
728	Software version option rev. of rotation incompatible	
732	Software version option Profibus incompatible	
736	Software version option Profinet incompatible	
740	Software version option universal interface incompatible	
744	Software version option Ethernet/IP incompatible	
748	Software version option Modbus TCP incompatible	
752	Software version option OPC UA incompatible	
756	Software version option CANOpen incompatible	
760	Software version option CAN Demag incompatible	
764	Software version option Calibrator incompatible	
768	Software version option Flow incompatible	
772	Software version option Multiflow incompatible	
776	Analog-Option fehlt oder defekt	Connect the corresponding option or switch off in the parameter Hardware options
780	Digital-Option fehlt oder defekt	
784	Current monitoring heating option missing or defective	

No.	Error message	Rectification
788	Rotation reversal option missing or defective	
792	Profibus option missing or faulty	
796	Profinet option missing or faulty	
800	Option Universalschnittstelle missing or faulty	
804	Ethernet/IP option missing or faulty	
808	Modbus TCP missing or faulty	
812	Option OPC UA missing or faulty	
816	CANOpen option missing or faulty	
820	CAN Demag option missing or faulty	
824	Flow option missing or defective	
828	MF 1-4 missing or defective	
832	MF 5-8 missing or defective	
836	MF 9-12 missing or defective	
840	MF 13-16 missing or defective	
844	Calibrator missing or defective	
848	Alarm Flow active in Multiflow Option	
852	Alarm Temperature active in Multiflow Option	Check temperature - adjust alarm settings if necessary
856	Alarm Delta T active in Multiflow Option	Check temperature difference - adjust alarm settings if necessary
860	AD converter failure	Replace base module
864	Attention - temperature control cabinet too high	Place the temperature control unit in a place with low ambient temperature
868	Turn on time refill exceeded	Check the cooling water circuit and the cooling circuit for leaks
872	Maximal operating time boost pump exceeded	Check the hose couplings to the consumer, rectify leaks if found
876	Temp. monitor cooling act, cooling disabled	Check the cooling and cooling water flow
880	Flow switch act	Check the outlet pressure (min. 0.7 bar must be present)
884	Min. flow rate underrun	Min. Check the minimum flow rate (the given minimum flow rate must be present)
888	Min. System pressure underrun	Check system pressure
892	Flow rate deviation too high	Large variation in the flow (there may be a leak in the circuit)
896	Flow monitor Min. pump pressure underrun	Check flow pressure
900	Max. temperature Sn3 exceeded	Max. temperature of the heat transfer medium may not exceed the maximum device temperature (if required, check the tool temperature)
904	Max. temperature Sn2 exceeded	
908	Max. temperature exceeded	
912	Heating thermostat triggered	Temperature control unit has become too hot - allow to cool and look for the cause
916	Alarm frequency converter	Remedy the frequency converter fault
920	Motor current underrun	Check the pump/pump motor (with Ohmmeter) and if required, replace them
924	Phase sequence failure	Correct the phase sequence (interchange 2 phases)
928	Phase sequence unidentified	Switch off phase sequence monitoring
932	Phase missing	Check the mains, input conductor and pump motor

No.	Error message	Rectification
936	Motor contactor malfunction	Check motor contactor and if required, replace it
940	Temperature sensor Sn1 failure	Replace temperature sensor Sn1
944	Temperature sensor Sn2 failure - switched to outlet control	Replace temperature sensor Sn2
948	Temperature sensor Sn3 failure	Replace temperature sensor Sn3
952	System pressure sensor inactive	Activate the system pressure sensor
956	System pressure sensor failure	Replace the system pressure sensor
960	Level 1 underrun	Refill heat transfer medium
964	Motor current exceeded	Check the pump/pump motor (with Ohmmeter) and if required, replace them
968	Power failure	Failure of the power supply or temperature control unit not switched off properly
972	Max. System pressure overrun	Check system pressure
976	Safety thermostat triggered	Temperature control unit has become too hot - Determine cause and reset thermostat
980	EXTERNAL SWITCHED OFF Kernbruch	Check monitoring (possible leakage)

Systemfehler/Systemmeldungen

Error message	Rectification
Leak stop not possible	Reduce the temperature
Leak stop not allowed	Unit is not allowed for leak stop
Suction not possible	Switch the unit to normal operation mode
Memory stick missing	Insert memory stick
Incompatible data on stick	Load current software version
Communication failure	Check the connection between the front panel and the base module
Software version error	Re-load software (applies to front panel and base module)
Data corrupt on stick	Insert new memory stick and re-load device parameters
Settings defect / data not loaded	Replace the memory stick
No data on USB stick or wrong file extension	Load the correct data on USB stick
More than 1 file on USB stick	Load the correct data on USB stick
Data failure - no data loaded from USB stick	Load the correct data on USB stick
Option not activated	Activate the option
Saving data	Data saving in progress
Data saved	Data saving finished
Data error - no data saved to USB stick	Replace the USB stick
Pump is off or has wrong direction	Adjust the pump rotating field
Please close tap	Close the tap on the outlet
Calibration done - Please open tap	Open the tap on the outlet
USB Slave Mode operation not possible	Switch on the temperature control unit again
Save/Load not possible in USB Slave Mode	Switch on the temperature control unit again
Save/Load not possible during device is on	Switch the temperature control unit to OFF
Error, password not reset	Enter the reset code correctly
Password reset	Password has been reset
Illegal operation	Observe the operating sequence
Zone 1 missing	Connect Zone 1, check address of Zone 1
Zone 2 missing	Connect Zone 2, check address of Zone 2

Maintenance



WARNING



The temperature control unit must be switched off before carrying out any maintenance work - press the main switch and disconnect from the mains.

The temperature control unit may still be pressurized - Danger of injury from escaping hot cooling water or steam.

Before disconnecting the feed lines to the temperature control unit/consumer, first allow the temperature control unit to cool down.

Periodic Inspections and Maintenance Procedures

The RT100 control system has a service interval display to simplify maintenance work on the temperature control unit. We recommend entering the corresponding maintenance interval (e.g., 2000 hours, see the RT100 control system programming instructions).

Please note that the instructions below are based on a daily operating time of 8 hours. In multi-shift operation, the inspections and maintenance procedures must be carried out at correspondingly shorter intervals. Defective parts must be repaired or replaced immediately.

- Temperature control unit inspections and maintenance procedures must be carried out by an expert
- Maintenance procedures involving electrical equipment may only be carried out by qualified electricians
- The RT100 control system unit may only be replaced when the mains plug is unplugged
- The safety valve should be vented from time to time by brief activation (blow off)

**WARNING**

Danger of magnetic fields in the case of feed pumps with magnetic drive.

Persons with pacemakers and surgically implanted metal parts must remain at a safe distance or should not be required to perform maintenance and repairs on these pumps.

When assembling the magnetic drive, the motor must be securely retained to prevent any possibility of fingers being crushed between components due to the magnetic forces.

All computers, data media, credit cards, electronic watches etc. must be kept at a safe distance.

Daily Inspections/Maintenance Procedures

- Check the entire temperature control circuit (temperature control unit, connecting lines, consumers, etc.) for leakage and repair any leaks immediately
- Check filters and clean if necessary

Monthly Inspections/Maintenance Procedures

- Inspect the cooling air inlet port of the pump motor to ensure that it is free of obstructions. Clean the port by blowing compressed air from inside to outside
- Clean the level switches
- Check filters and clean if necessary



Semi-annual Inspections/Maintenance Procedures

- Inspect the electrical equipment such as grounding wires, secure connection of power supply cord and connecting lines, etc.
- Dismantle solenoid valves (see maintenance section), inspect membranes for lime deposits and damage. Check the core and spring bolt for free movement. Clean or replace parts if necessary
- Descale cooler - exercise caution when tightening the screwed connections on the heat exchanger (max. 170 Nm).
- Check pump capacity (the flow rate and final pressure must comply with the pump characteristic)

Annual Inspections/Maintenance Procedures

- Replace the heat transfer medium (water and corrosion inhibitor) after approx. 2000 working hours (equivalent to approx. one year in single-shift operation). In the event of poor water quality or multi-shift operation (contamination, etc.), the medium must be replaced correspondingly earlier



Cleaning

 CAUTION	
	<p>Always allow the temperature control unit to cool down.</p> <p>Switch off the temperature control unit: press the main switch and unplug from the mains.</p> <p>When using a solvent for cleaning - do not blow out the tank and the cooler, but flush them instead (explosion hazard).</p> <p>When using a solvent, the manufacturer's instructions for use must be observed. Solvents are flammable under certain conditions. For this reason, cleaning must never take place near heat sources.</p>

In the event of unfavourable operating conditions, the procedures listed below must be carried out correspondingly earlier.

- 1) Drain the temperature control unit by suction or blowing out
- 2) Clean the filters in the circuit
- 3) Inspect the cooler for scale deposits and clean using the REG Descaling Unit if necessary
- 4) Level control - remove and clean the level switches. Important - reinstall level switch correctly (**NO** marking must be on top, see Maintenance section)
- 5) Dismantle solenoid valves (see Maintenance section), inspect diaphragms for scale deposits and damage. Check the core and spring bolt for free movement. Clean or replace parts if necessary
- 6) Inspect pump for corrosion and replace if necessary
- 7) It is also advisable to inspect the consumers for contamination. Impurities lead to a sharp reduction in heat exchange between consumer and heat transfer medium. Deposits increase the pressure drop in the consumer, so that, over time, the pump capacity of the temperature control unit is no longer sufficient to handle the necessary heating or cooling load

Repairs

 CAUTION	
	<p>Allow the temperature control unit to cool down and, if necessary, drain it before any repair.</p> <p>Switch off the temperature control unit: press the main switch and unplug from the mains.</p> <p>Disconnect all hose couplings from the temperature control unit.</p>

For fast, error-free supply of spares, we need the following data without fail:

- Device type
- Device number
- Voltage and frequency

This information is given on the rating plate on the temperature control unit.

The item numbers of the components can be found in the corresponding drawings in these operating instructions and the electrical circuit diagrams of the temperature control unit.

CAUTION



Only authentic (OEM) Regloplas spare parts may be used. In case of damage from the use of non-OEM parts, the warranty will be rendered null and void.

Transport

CAUTION



Allow the temperature control unit to cool down; switch off - press the main switch and disconnect from mains (see chapter on "Switching off the temperature control unit").

Disconnect all hose couplings from the temperature control unit.

Before shipping, the temperature control unit must be drained through the discharge port on the delivery pump (see Maintenance section). Because of the danger of freezing (bursting of the cooling pipes) at low temperatures, the cooler must be blown out as follows:



1) Switch on the temperature control unit - press the main switch and press the **ON/OFF** button

2) Set the set-point value on the controller to 0 °C

3) Check that the cooler solenoid valve (**Y6**) is open

4) Blow out the cooler with compressed air (max. 6 bar)



5) Switch off the temperature control unit with the **ON/OFF** button, and then press the main switch and unplug the mains plug

6) Do not tip the temperature control unit - heat transfer medium remaining in the unit could spill out

7) Use the original packaging and mark the top side clearly

Disposal

The temperature control unit must be drained completely and disposed of in accordance with local regulations.

The temperature control unit can also be returned to Regloplas AG, Switzerland, for disposal.

Maintenance

Technical Data 90XL

Temperature Control Unit Type	90XL			
Max. outlet temperature	90 °C			
Heat transfer medium	Water			
Filling capacity	36.5 l			
Expansion volume	5.5 l			
Heating capacity	20/40/60 kW			
Heating switch	Contactor/SSR			
Cooling capacity	160 kW			
at outlet temperature	80 °C			
at cooling water temperature	20 °C			
Pump type	CR5-3	CR5-8	CR10-4	CR10-8
Motor power (pump)	0.55 kW	1.1 kW	1.5 kW	3.0 kW
Motor current (pump), 400 V/50 Hz	1.44 A	2.6 A	3.4 A	6.25 A
Max. delivery rate	140 l/min	140 l/min	200 l/min	200 l/min
Max. delivery pressure	2.0 bar	5.4 bar	4.4 bar	8.7 bar
Control System	RT200 Control System			
Measurement type (standard)	Pt100			
Control voltage	230 V, 50/60 Hz			
Input supply voltages	200-600 V, 50/60 Hz			
Total power at 400 V/50 Hz	(see specification plate)			
Outlet/inlet connections (standard)	G 1 1/2" (female)			
Cooling water supply connections (standard)	G 3/4"			
Degree of protection	IP54			
Dimensions W/H/D	432/1350/1387 mm			
Weight	229-275 kg			
Colour	RAL 9006/7016			
Ambient temperature	10 °C - 40°C			
Continuous sound pressure level	< 70 dB(A)			

Block Diagram 90XL

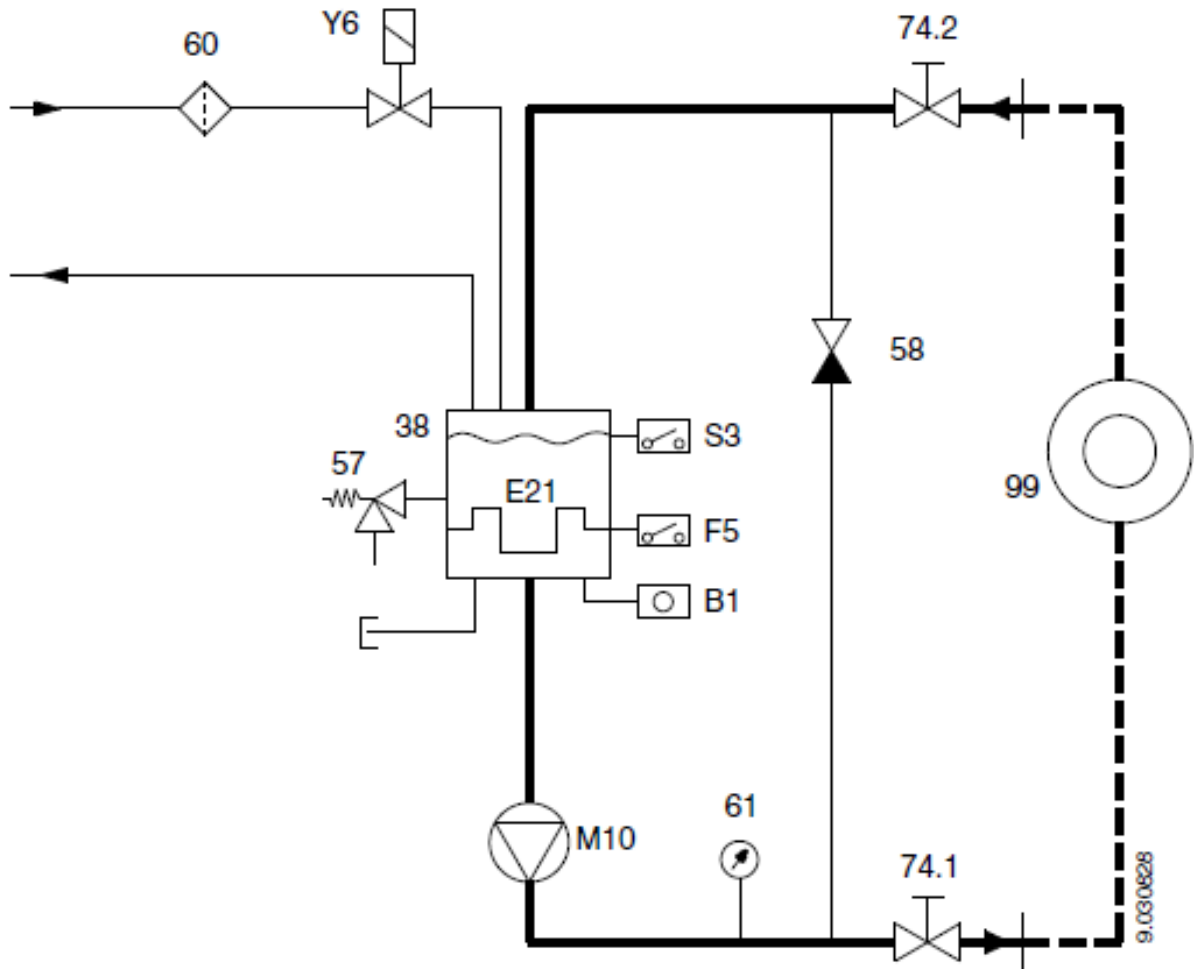

Block Diagram 90XL

Item	Designation	Item	Designation
38	Tank	99	Consumer
57	Safety valve	B1	Temperature probe, internal
58	Bypass	E21	Heating
60	Filter - cooling circuit	F5	Safety thermostat
61	Pressure gauge	M10	Pump
74.1	Manual valve	S3	Level control
74.2	Manual valve	Y6	Solenoid valve - cooling

Graph (pump capacity)

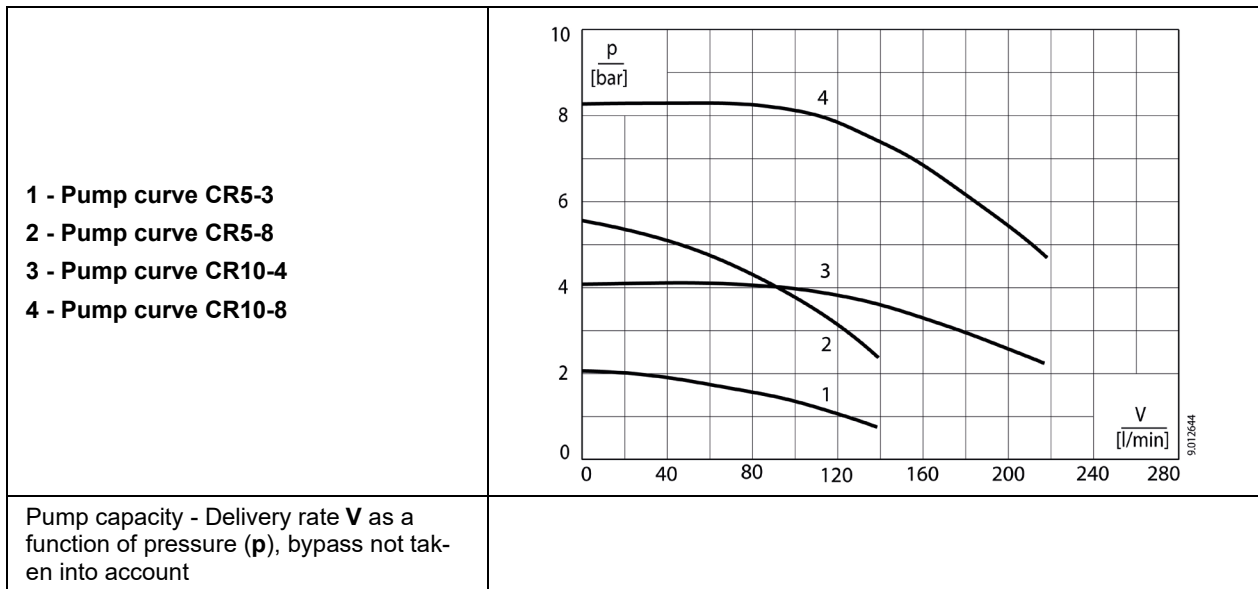

Graph (cooling capacity)

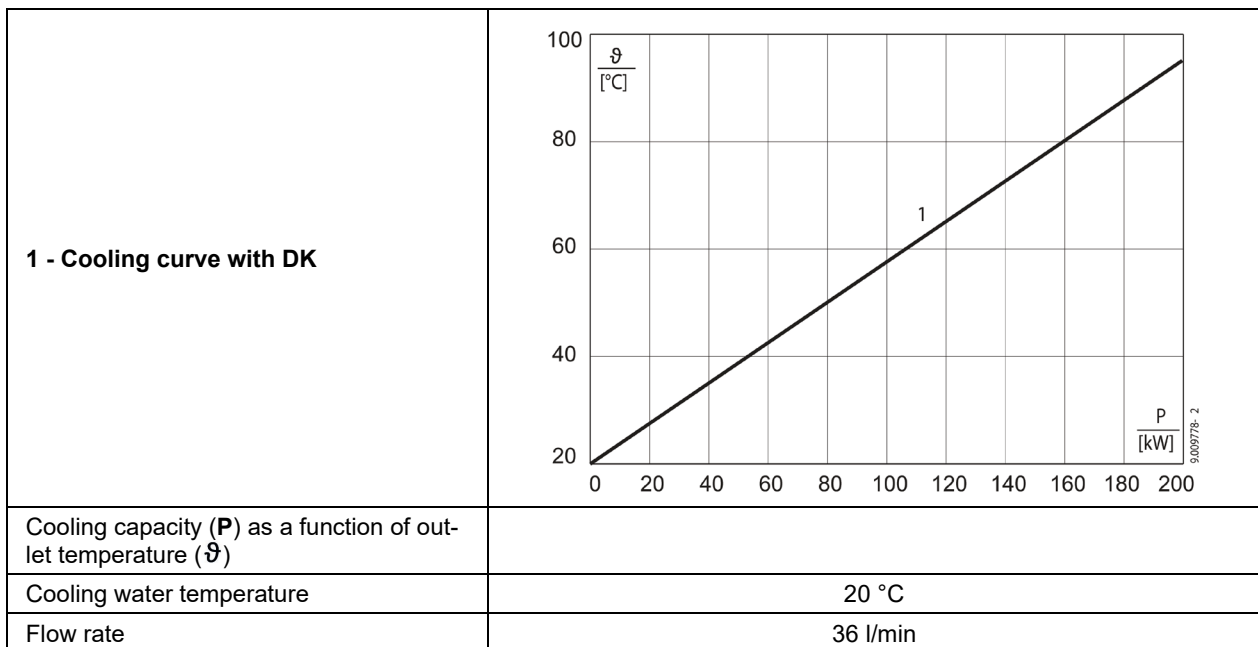

Components/Spare parts 90XL

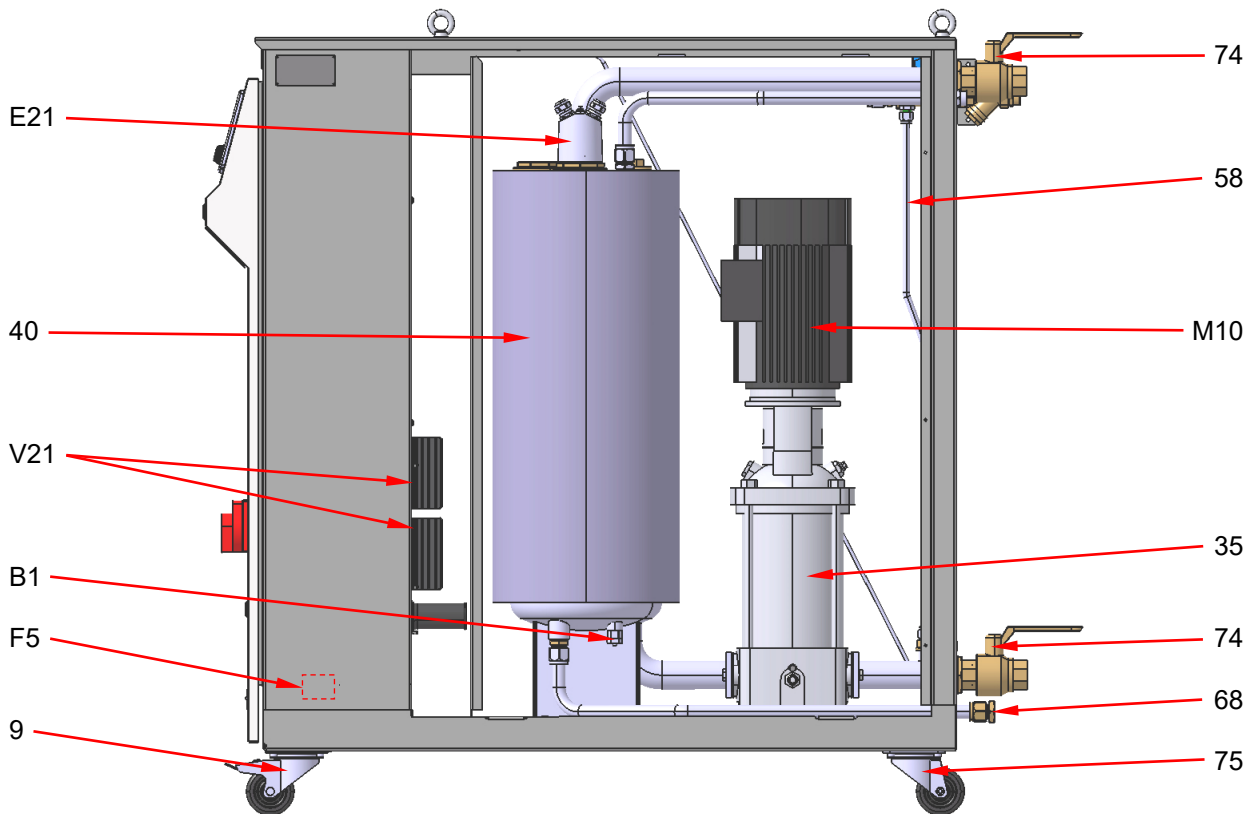
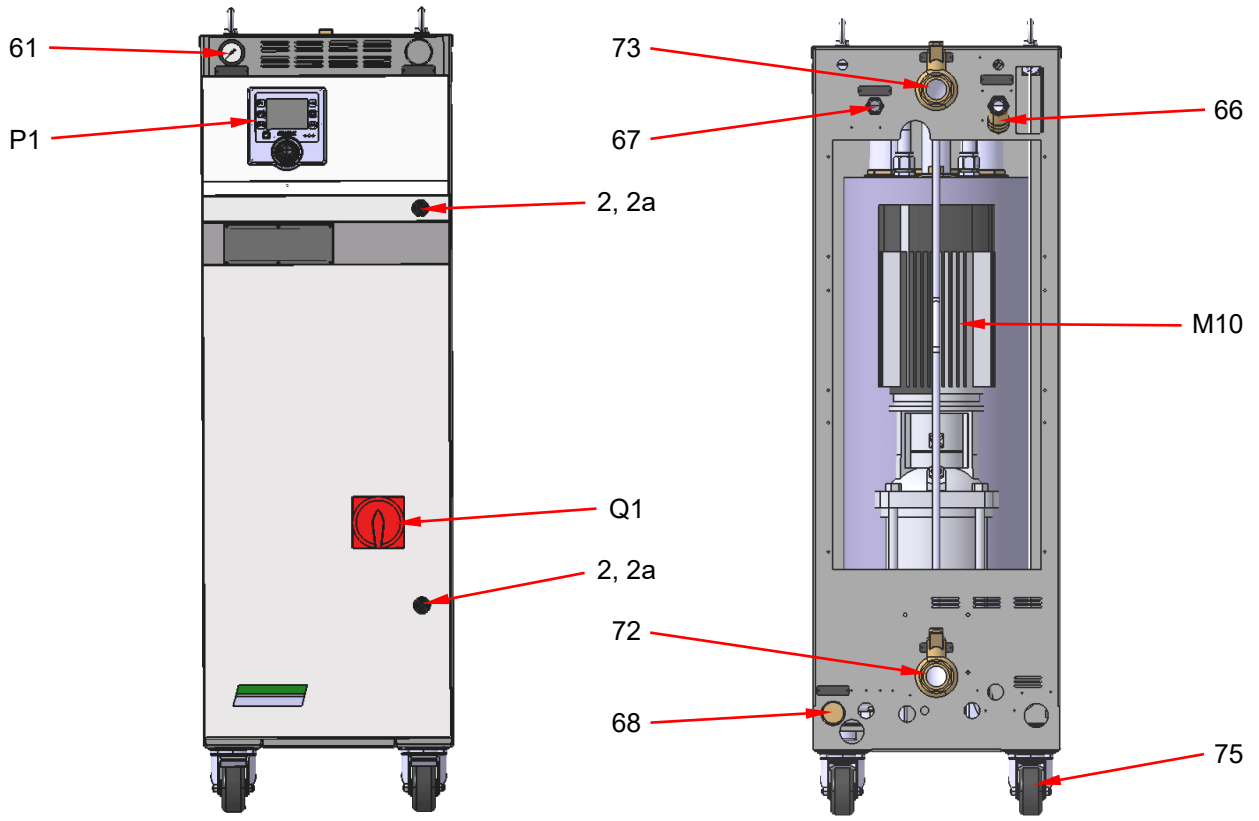

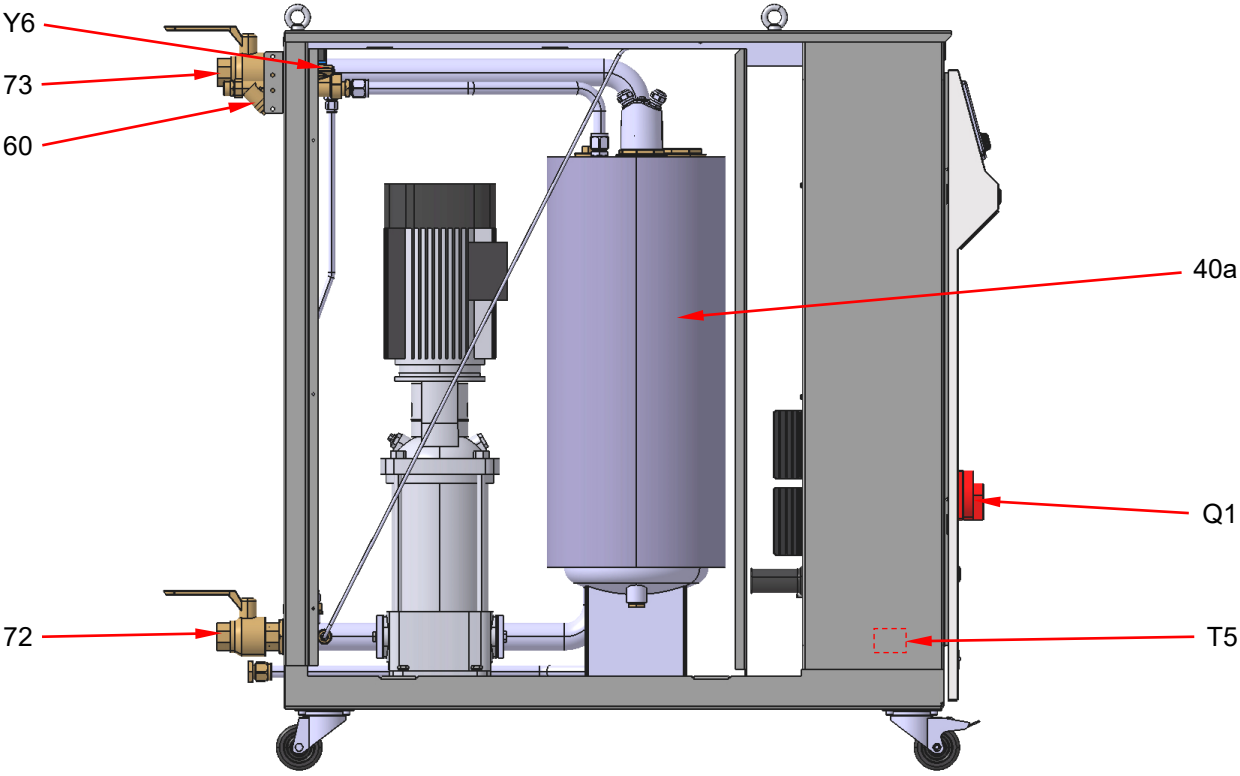



Components/Spare parts 90XL

Item	Designation	Item	Designation
2	Lock	B1	Temperature probe - internal
2a	Locking tongue	E21	Heating
9	Castor with wheel lock	F5	Safety thermostat
35	Pump	M10	Pump motor
40	System with heating	P1	Control system
40a	Insulation (system)	Q1	Main switch
58	Bypass	S3	Level switch (see corresponding chapter)
60	Filter - cooling water	T5	Control transformer
61	Pressure gauge	V21	SSR relay with heat sink
66	Cooling water IN	Y6	Solenoid valve (cooling)
67	Cooling water OUT		
68	Discharge port		
72	Outlet		
73	Inlet		
74	Manual valve		
75	Castor		

NOTE	
	See electrical wiring diagram of the temperature control unit for additional electrical components!

 CAUTION	
	Only authentic (OEM) Regloplas spare parts may be used. In case of damage from the use of non-OEM parts, the warranty will be rendered null and void!

Dimension Sheet 90XL

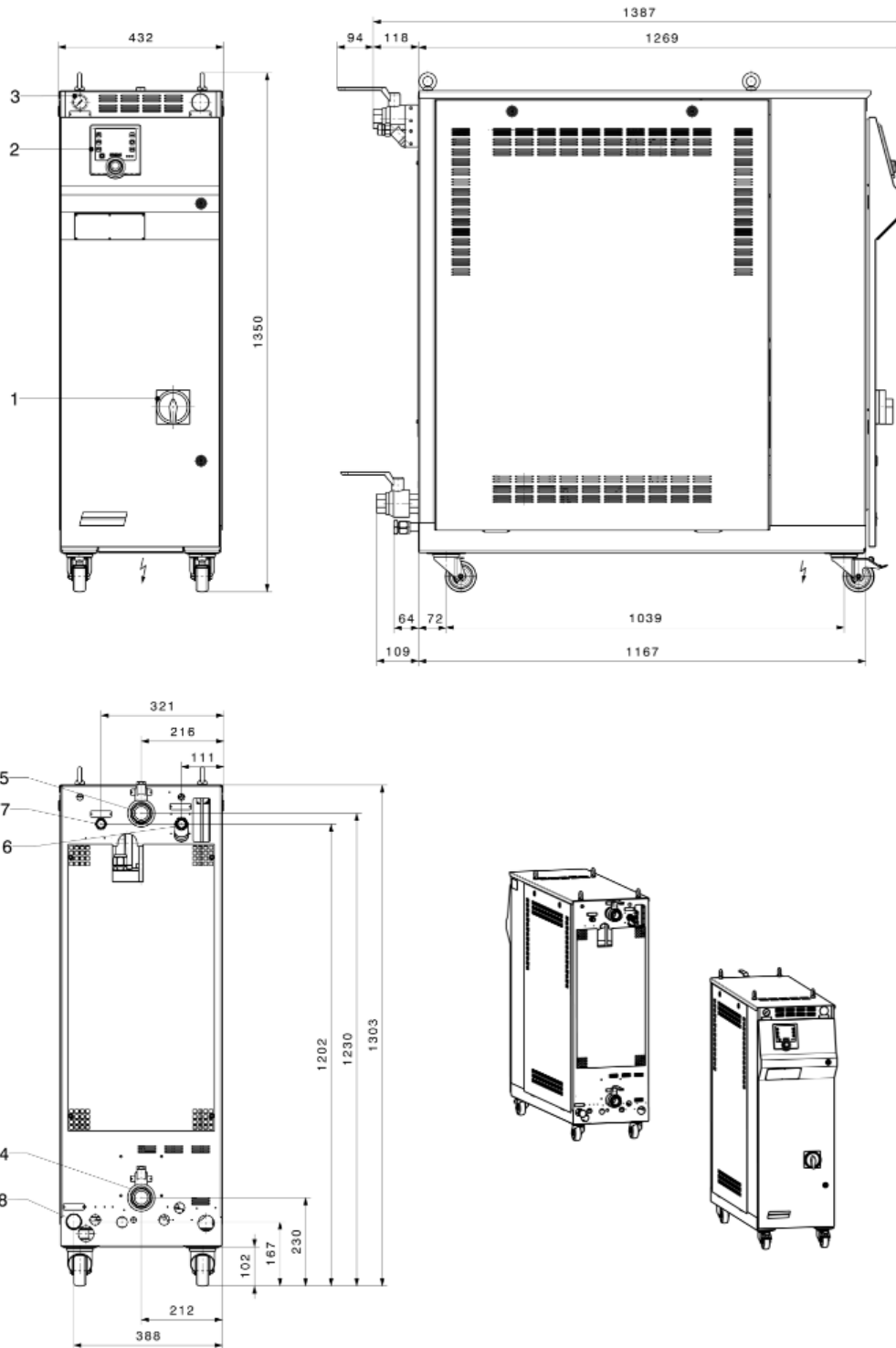

Item	Designation	Item	Designation
1	Main switch	5	Inlet
2	RT100 Control System	6	Cooling water IN
3	Pressure gauge	7	Cooling water OUT
4	Outlet	8	Discharge port

Solenoid valve Y6

Overview

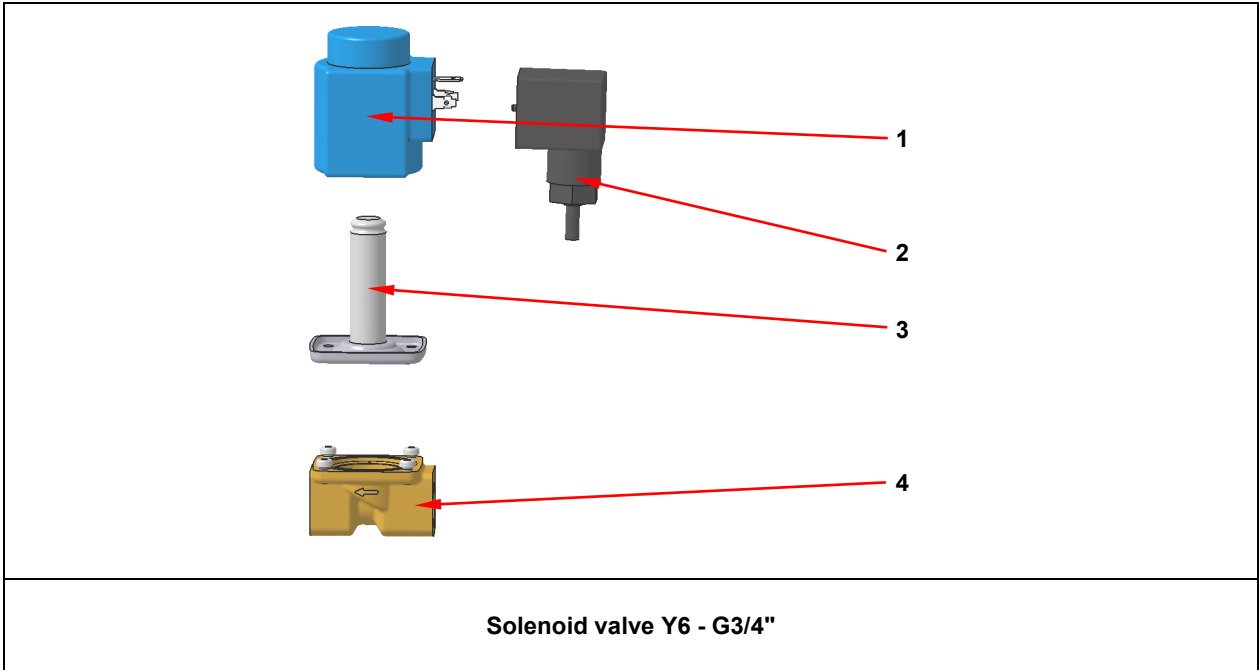

Item	Designation	Item	Designation
1	Female connector	3	Armature guide with armature and spring
2	Coil	4	Housing with diaphragm and O-ring

Level Switches

Dismantling/Replacement

